

VIKING



LA LAMA IN ACCIAIO CHE RICORDA IL PROFILO DI CHIGLIA DELLE NAVI VICHINGHE È LA SPINA DORSALE DI TUTTE LE SEDUTE CHE FANNO PARTE DELLA COLLEZIONE. SU DI ESSA SI INNESTANO IL FONDELLO LO SCHIENALE E GLI APPOGGI A TERRA. IL TELAIO È IN ACCIAIO, MENTRE I COMPONENTI DI SEDUTA E SCHIENALE SONO DISPONIBILI IN MULTISTRATO O CUOIO.

The steel blade recalling the contour of the keel of Viking ships is the backbone of all the chairs belonging to this collection. The chair seat, the backrest and the chair legs are inserted onto this. The chair frame is made of steel, while the seat and backrest are available in either plywood or leather.

La lame en acier qui rappelle le profil de la quille des navires vikings est l'épine dorsale de toutes les assises qui font partie de la collection. C'est sur elle que s'enclenchent le fond, le dossier et les appuis au sol. Le châssis est en acier alors que les composants de l'assise et du dossier sont disponibles en multicouche ou en cuir.

Ein Stahlprofil, das an den Rumpf der Wikingerschiffe erinnert, stellt das Rückgrat aller Stühle dieser Kollektion dar, an dem die Sitzfläche, die Rückenlehne und die Bodenstützen befestigt sind. Der Rahmen ist aus Stahl gefertigt, während die Sitzflächen und die Lehnen in Sperrholz oder Leder erhältlich sind.

La cuchilla de acero que recuerda el perfil de la quilla de los barcos vikingos, es la espina dorsal de todos los asientos que forman parte de la colección. Sobre ella, se ensamblan el fondo, el respaldo y los apoyos en el suelo. El bastidor es de acero, mientras que los componentes del asiento y el respaldo, están disponibles en madera estratificada o cuero.



Schienale adattivo
Adjustable backrest
Dossier adaptatif
Adaptive Rückenlehne
Respaldo adaptable



ADAPTIVE
CHAIR BACKREST
registered community
design













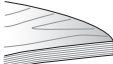





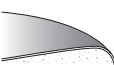









Sfoderabile
Removable upholstery
Déhoussable
Abnehmbares Polsterzeug
Cubierta desmontable



Piedini intercambiabili
Interchangeable feet
Pieds interchangeables
Austauschbare Füße
Pies intercambiables

FINITURE/FINISHES

fondello e schienale / seat and back

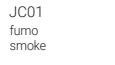
| | | | | | | |
|---|--|---|---|---|---|---|
|  | essenze woods |  |  |  |  |  |
| | | Y36 rovere oak | Y34 noce walnut | Y37 rovere affumicato smoked oak | Y40 frassino argilla clay ash | Y39 frassino nero black ash |
|  | cuoio cow-hide |  |  | | | |
| | | F01 tabacco tobacco | F02 nero black | | | |
|  | 100% poliestere/polyester peso/weight: 400 gr/mq BSI : 50.000 cicli/cycles |  |  |  |  |  |
| | | JA01 perla pearl | JA02 avorio ivory | JA03 fango mud | JA04 salvia sage | JA05 oliva olive |
|  | 50% cotone/cotton 40% poliestere/polyester 10% poliacrilico/polyacrylic peso/weight: 430 gr/mq BSI : 40.000 cicli/cycles |  |  |  |  |  |
| | | JB01 natur natur | JB02 ecru ecru | JB03 grigio grey | JB04 cenere ash | JB05 platino platinum |
|  | 60% lino/linen 40% viscosa/viscose peso/weight: 550 gr/mq BSI : 20.000 cicli/cycles |  |  |  |  |  |
| | | JC01 fumo smoke | JC02 cenere ash | JC03 sacco sack | JC04 terra land | JC05 verde green |
| | |  | | | | |
| | | JC06 rosa pink | | | | |

telaio / structure

| | | | | | | | |
|---|----------------------------------|---|---|---|---|---|---|
|  | acciaio verniciato painted steel |  |  |  |  |  |  |
| | | C12 bianco white | C21 seta silk | C23 corda ecru | C30 ghisa cast-iron | C14 antracite anthracite | C08 nero black |
| | |  |  |  |  |  | |
| | | C18 verde green | C26 corten corten | C29 bronzo bronze | C37 rame copper | C38 titanio titanium | |

DIMENSIONI/DIMENSIONS

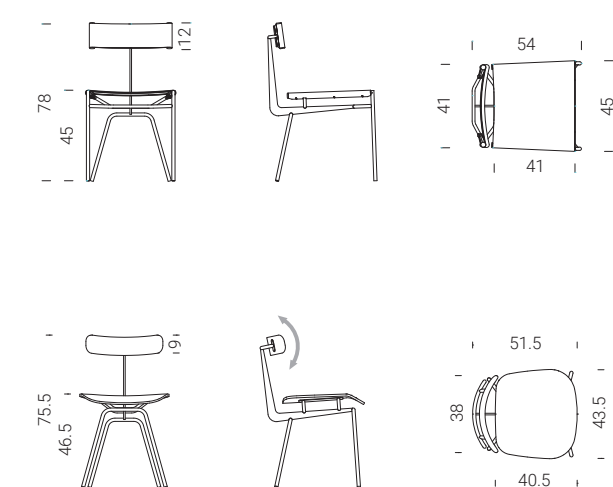

verificare a listino disponibilità, composizione e consigli di lavaggio per i tessuti.
check availability, composition and washing recommendations for fabrics in the price list.