

PERSONAL

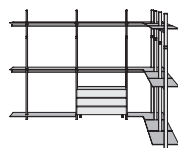

IL SISTEMA BREVETTATO EXTENDO È FORMATO DA DUE PROFILI IN ALLUMINIO ESTENSIBILI, ADATTABILI ALLE DIVERSE ALTEZZE DEGLI AMBIENTI. AGENDO SULLA LEVA A SCOMPARSA, I PROFILI SI BLOCCANO ALL'ALTEZZA DESIDERATA E SI COMPRIMONO TRA PAVIMENTO E SOFFITTO, SENZA L'UTILIZZO DI ALCUN UTENSILE O PRE-FISSAGGIO.

The patented extendo system consists of two extendable aluminium profiles that can be adapted to environments of various heights. Using the foldaway lever, the profiles can be blocked at the desired height and compressed between floor and ceiling, without having to use any kind of pre-fixing tool.

Le système breveté extendo est constitué de deux profils extensibles en aluminium pouvant être adaptés aux différentes hauteurs des milieux. En agissant sur le levier escamotable, les profils se verrouillent à la hauteur souhaitée et se compriment entre plancher et plafond, sans utiliser aucun outil ou préfixation.

Das patentierte System extendo besteht aus zwei ausziehbaren Aluminium-Profilen, die an unterschiedliche Raumhöhen angepasst werden können. Durch einen versenkbaren Hebel werden die Profile auf der gewünschten Höhe blockiert und zwischen Fußboden und Zimmerdecke ohne Werkzeug oder Vor-Befestigung komprimiert eingesetzt.

El sistema patentado extendo está formado por dos perfiles de aluminio extensibles, adaptables a las distintas alturas de los ambientes. Actuando sobre la palanca escondida, los perfiles se bloquean a la altura deseada y se comprimen entre el suelo y el techo, sin que sea necesario utilizar ninguna herramienta o fijación previa.

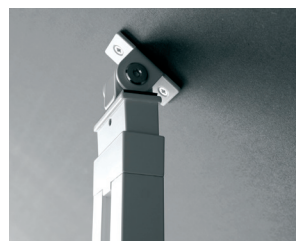
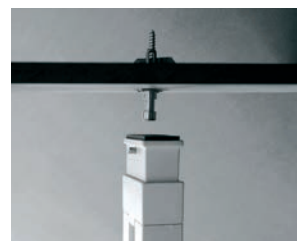
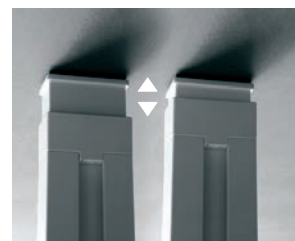
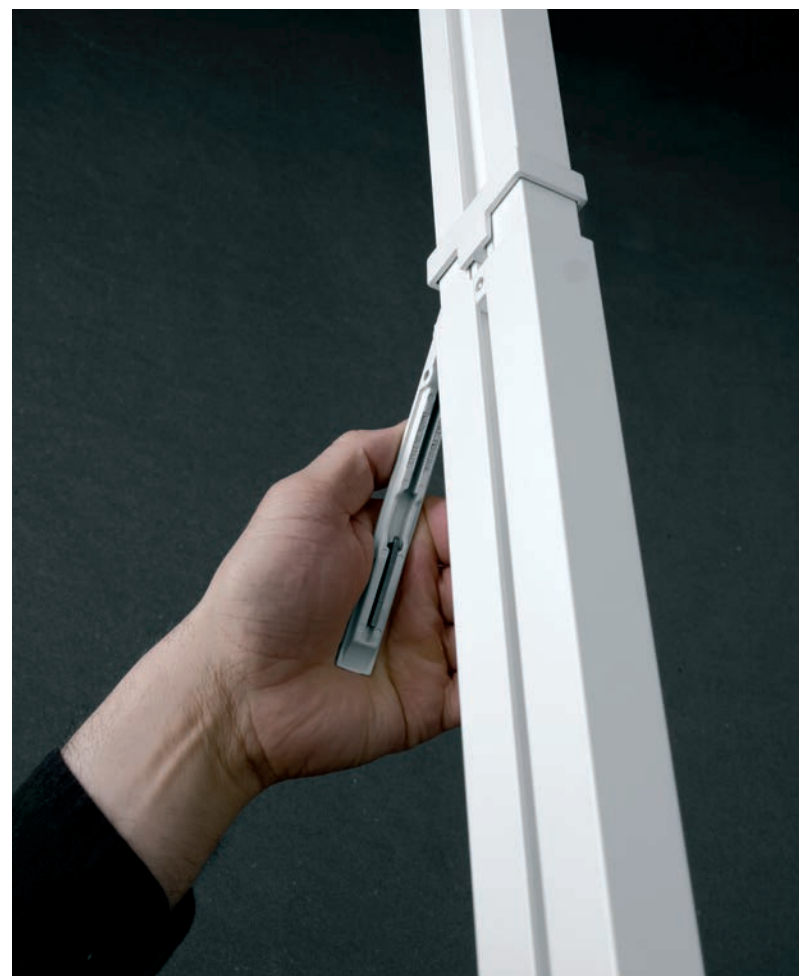
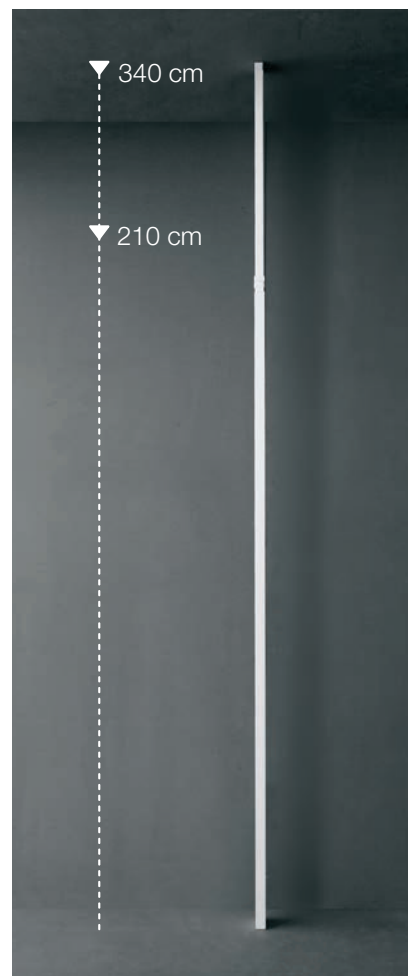

PRODUCT CONCEPT

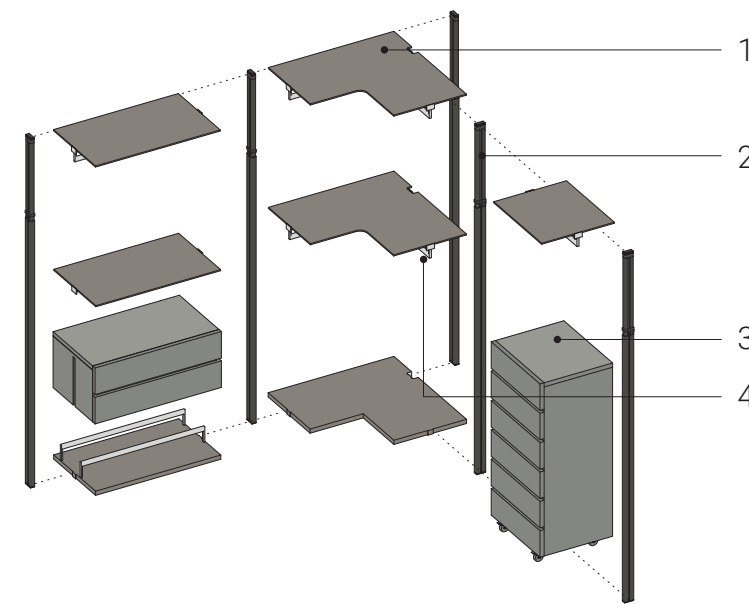

L
60 - 90 - 120
H
210 / 400

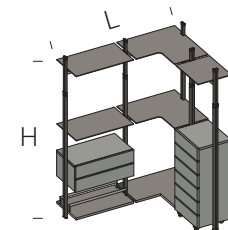

Ripiani e contenitori hanno libera posizione in altezza, (al centimetro).
Shelves and containers can be positioned at any height (to the centimetre).
Les étagères et les conteneurs peuvent être positionnés librement en hauteur (au centimètre près).
Einlegeböden und Behälter sind in der Höhe frei einsetzbar (auf den Zentimeter).
Los estantes y contenedores tienen una altura libre (al centimetro).



Pavimento / soffitto
Floor / ceiling
Sol / plafond
Boden / Decke
Suelo / techo

Pavimento / parete
Floor / wall
Sol / mur
Boden / Wand
Suelo / pared

Soffitto inclinato
Sloping ceiling
Plafond incliné
Schräge Decke
Techo inclinado



I ripiani a modulo 60/90/120 cm. ed angolari sono disponibili in finitura melaminico, laccato e vetro. In tutte le finiture è prevista la riduzione a misura.

The 60/90/120 cm shelves and corner pieces are available in melamine, lacquered and glass finish. Measurement reduction is available for all the finishes.

Les étagères du module 60/90/120 cm et les pièces d'angle sont disponibles dans les finitions en mélamine, laquées et en verre. Une réduction de taille est possible dans toutes les finitions.

Die Modul-Einlegeböden 60/90/120 cm und die Eckmodule sind mit den Beschichtungen Melamin, lackiert und Glas verfügbar. In allen Beschichtungen ist die Verkürzung nach Kundenwunsch möglich.

Los estantes modulares y de esquina de 60/90/120 cm están disponibles en acabados de melamina, lacado y cristal. La reducción de tamaño es posible en todos los acabados.



Le cassettiere a modulo 60/90/120 cm a 2/3/4/6 cassetti, sono disponibili in finitura melaminico e laccato. Sono disponibili in versione su ruote o sospese.

The 60/90/120 cm module chests of drawers with 2/3/4/6 drawers, are available in melamine and lacquered finish. They are available with wheels or in the suspended version.

Les blocs tiroirs 60/90/120 cm avec 2/3/4/6 tiroirs sont disponibles avec finitions en mélamine et laquées. Ils sont disponibles en versions à roulettes ou suspendues.

Die Modul-Schubladenschränke 60/90/120 cm mit 2/3/4/6 Schubladen sind mit den Beschichtungen Melamin und lackiert verfügbar. Sie sind in den Versionen auf Rädern oder aufgehängt verfügbar.

Las cajoneras modulares de 60/90/120 cm con 2/3/4/6 cajones están disponibles en acabado melamina y lacado. Están disponibles en versión con ruedas o suspendidas.



I profili in alluminio estruso, sono configurabili per adattarsi alle diverse esigenze degli ambienti. Sono infatti possibili configurazioni per installazioni a soffitto, parete e soffitto inclinato.

The extruded aluminium profiles are modular, to adapt to the needs of the spaces. Indeed, configurations are available for ceiling, wall and sloping ceiling mounting.

Les profilés en aluminium extrudé peuvent être configurés pour s'adapter aux différents besoins des espaces. En effet, des configurations pour des installations au plafond, murales et sur plafond incliné sont possibles.

Die Profile aus extrudiertem Aluminium sind gestaltbar, um sich an die verschiedenen Anforderungen der Räume anzupassen. Es sind nämlich Konfigurationen für die Montage an der Decke, an der Wand und an schräger Decke möglich.

Los perfiles de aluminio extruido pueden configurarse para adaptarse a los distintos requisitos del entorno. Las configuraciones son posibles para instalaciones en el techo, en la pared y en el techo inclinado.



Le barre appendiera sono in alluminio verniciato a polveri a 180°. Esse si possono installare sotto il ripiano o direttamente tra i due profili verticali.

The hanging rails are in 180° powder coated aluminium. These can be installed below the shelf or directly between the two vertical profiles.

Les barres de penderie sont en aluminium peint à la poudre à 180°. Elles peuvent être installées sous l'étagère ou directement entre les deux profilés verticaux.

Die Aufhängestangen sind aus 180°-pulverlackiertem Aluminium. Sie können unter dem Einlegeboden oder direkt zwischen den zwei vertikalen Profilen montiert werden.

Las barras de suspensión son de aluminio con recubrimiento de polvo a 180°. Pueden instalarse bajo la estantería o directamente entre los dos perfiles verticales.



Riduzioni a misura disponibili su profili verticali, ripiani e barre appendiera.
Measurement reductions available on vertical profiles, shelves and hanging rails.
Réductions sur mesure possibles sur les profilés verticaux, les étagères et les barres de penderie.
Verkürzungen nach Kundenwunsch für vertikale Profile, Einlegeböden und Aufhängestangen verfügbar.
Reducciones de tamaño disponibles en perfiles verticales, estantes y barras de colgar.

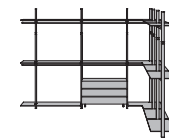

Profilo telescopico brevettato
Patented telescopic profile
Profilé télescopique breveté
Patentiertes teleskopisches Profil
Perfil telescópico patentado

FINITURE/FINISHES

profilo extendo / extendo profile



DIMENSIONI/DIMENSIONS

verificare a listino dimensioni e finiture
check dimensions and finishes in the price list

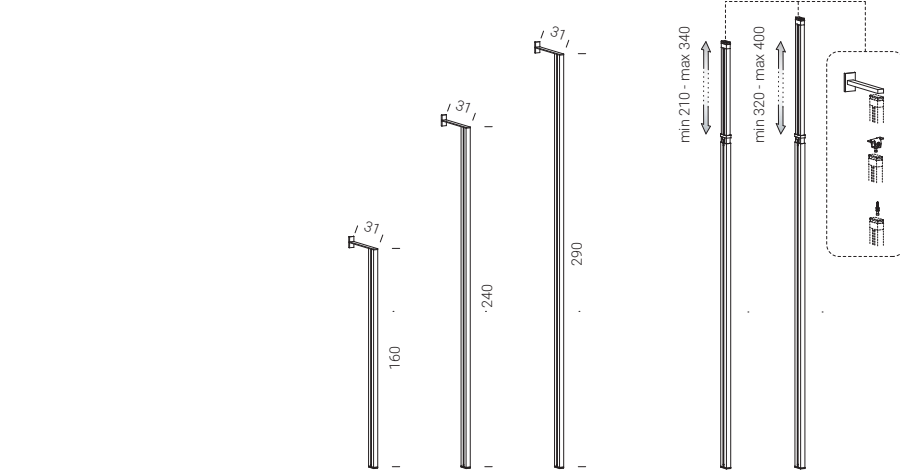

cm disponibili riduzioni a misura / tailor-made reduction available

ripiani in agglomerato ligneo / wood composite shelves

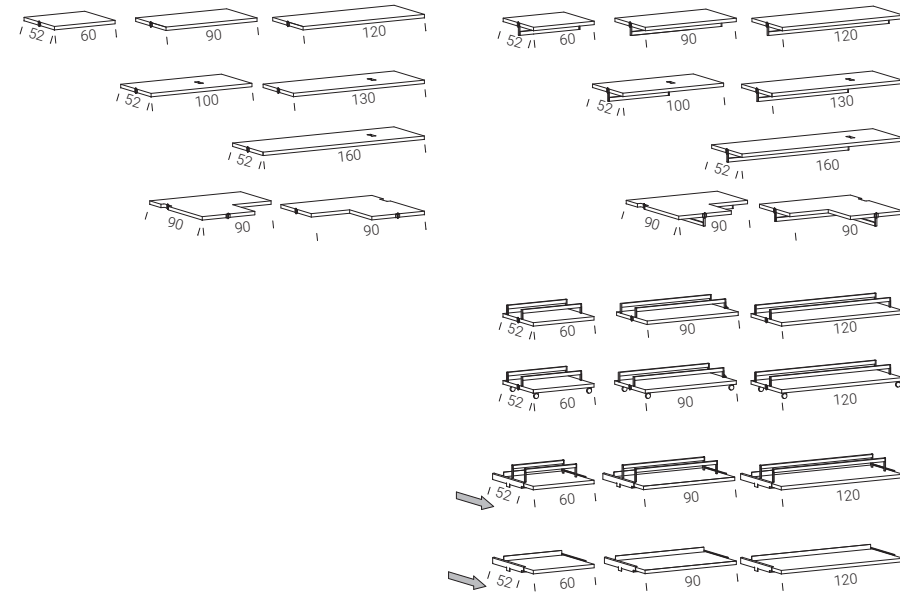
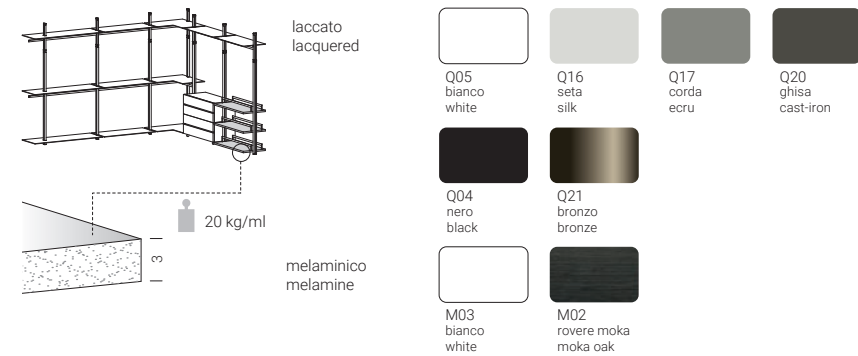

cm disponibili riduzioni a misura / tailor-made reduction available

FINITURE/FINISHES

ripiani in vetro / glass shelves

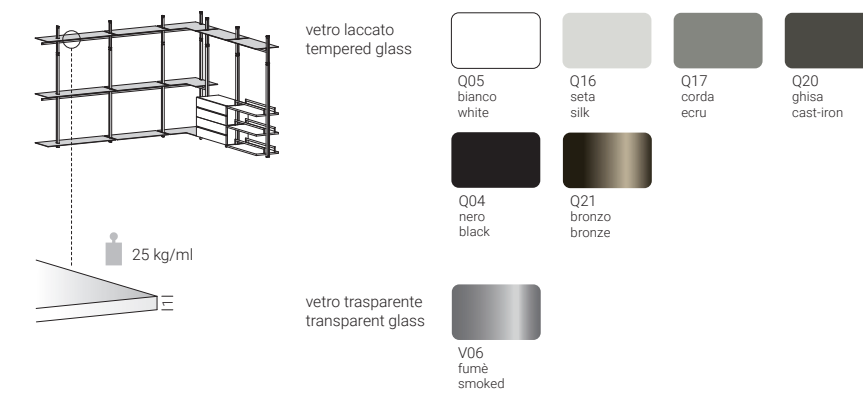

contenitori / cabinets



accessori / accessories

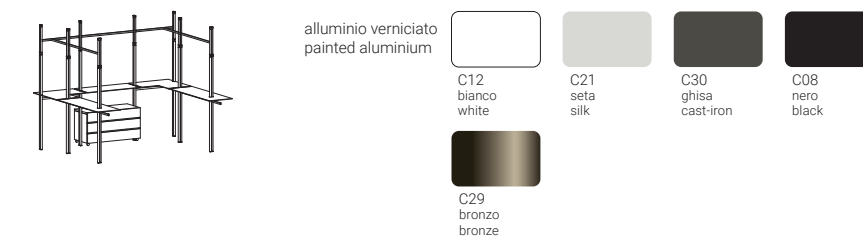

DIMENSIONI/DIMENSIONS

verificare a listino dimensioni e finiture
check dimensions and finishes in the price list

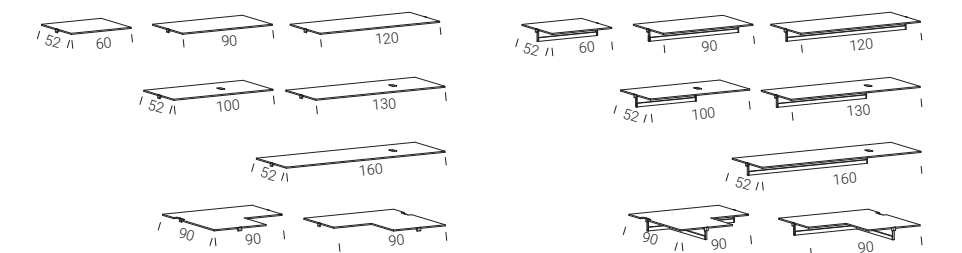

cm disponibili riduzioni a misura / tailor-made reduction available

